

PLANTILLA DE ANCLAJES

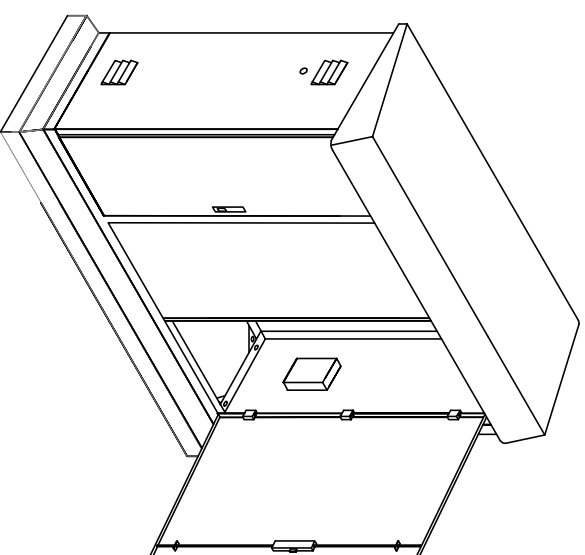
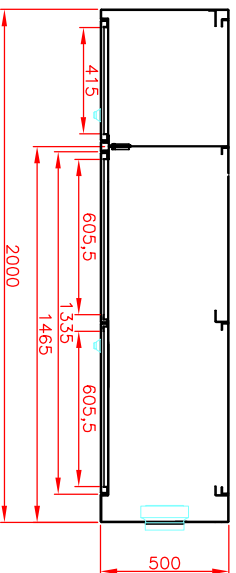
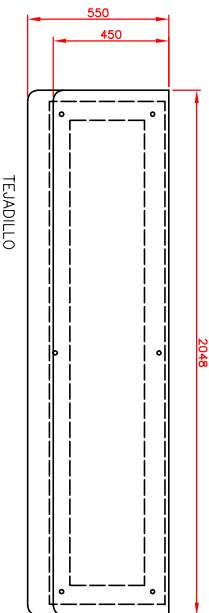
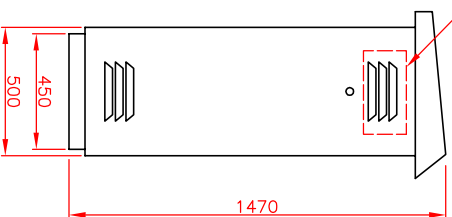
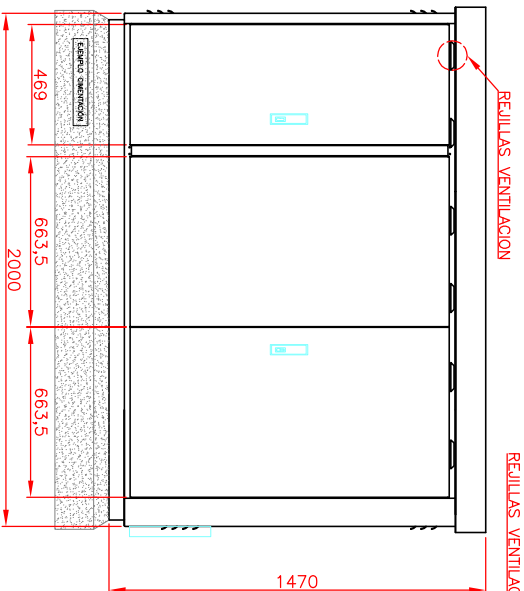
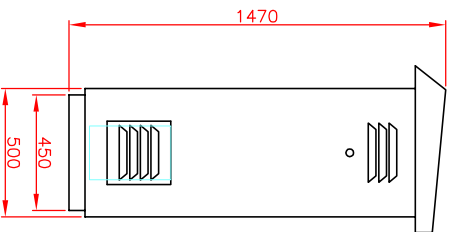
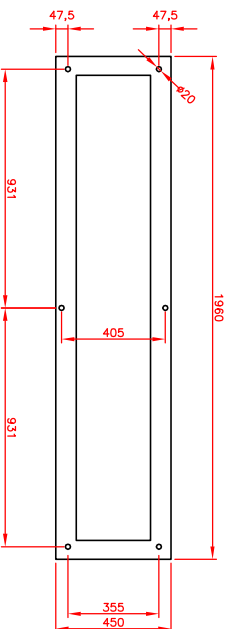

PERSPECTIVA DEL ARMARIO (s/esc.)

Fecha	07-05-09	Nombre	J.C. DIAZ	FIRMADO	Materia	ACERO 3 mm
Comprob.	07-05-09		F.RAMIREZ		Acabado	GALV. CALENTE
Id.s.normas	s/e		s/e			
Escala	1:20 (A3)	Descripción		CENTRO DE MANDO DE ALUMBRADO PÚBLICO		
Revisión	0	ARMARIO APM6R		- DIMENSIONES -		
				Número Plano	PINAZO INDUSTRIAS ELECTRICAS	
				Sustituye o	APM6R	
				Sustituido por		